

CA164753

HARRIS ESD

153 x 95 x 72

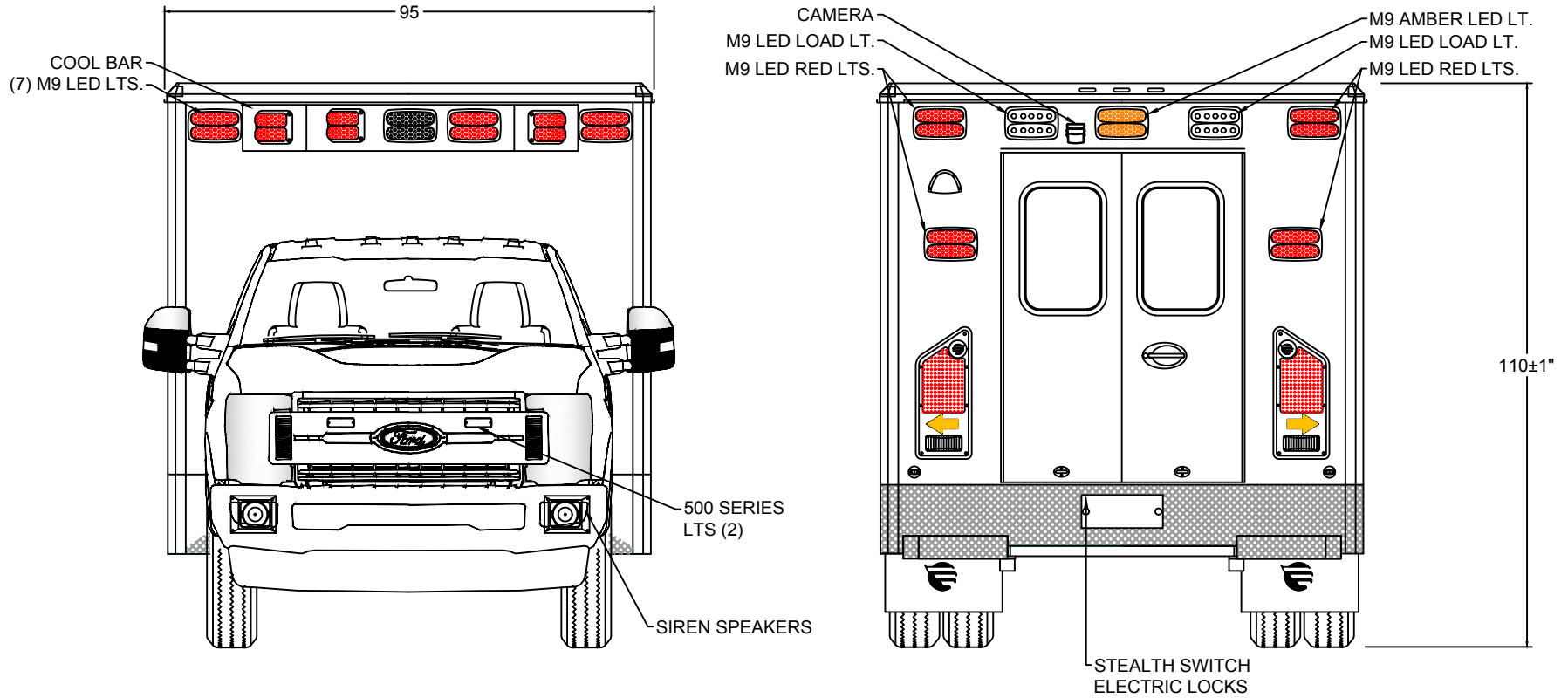

EXTERIOR COMPARTMENT DIMENSIONS IN INCHES

INTERIOR DIMENSIONS				PASS THRU		INTERIOR DIMENSIONS				JAMB OPENING	
COMPT.	HEIGHT	WIDTH	DEPTH	HEIGHT	WIDTH	COMPT.	HEIGHT	WIDTH	DEPTH	HEIGHT	WIDTH



F450 TYPE 1 FORD 2018
FRONT / REAR
EXTERIOR VIEWS

BE ADVISED THAT THESE ARE PRELIMINARY LAYOUTS INTENDED TO ILLUSTRATE DESIGN INTENT AND DIMENSIONS ARE FOR REFERENCE ONLY PRIOR TO FINAL ENGINEERING

DATE:	08/21/18	SCALE
DWN BY:	SG	DWG NO 1 / 9

55" AISLE

CA164753

HARRIS ESD

153 x 95 x 72

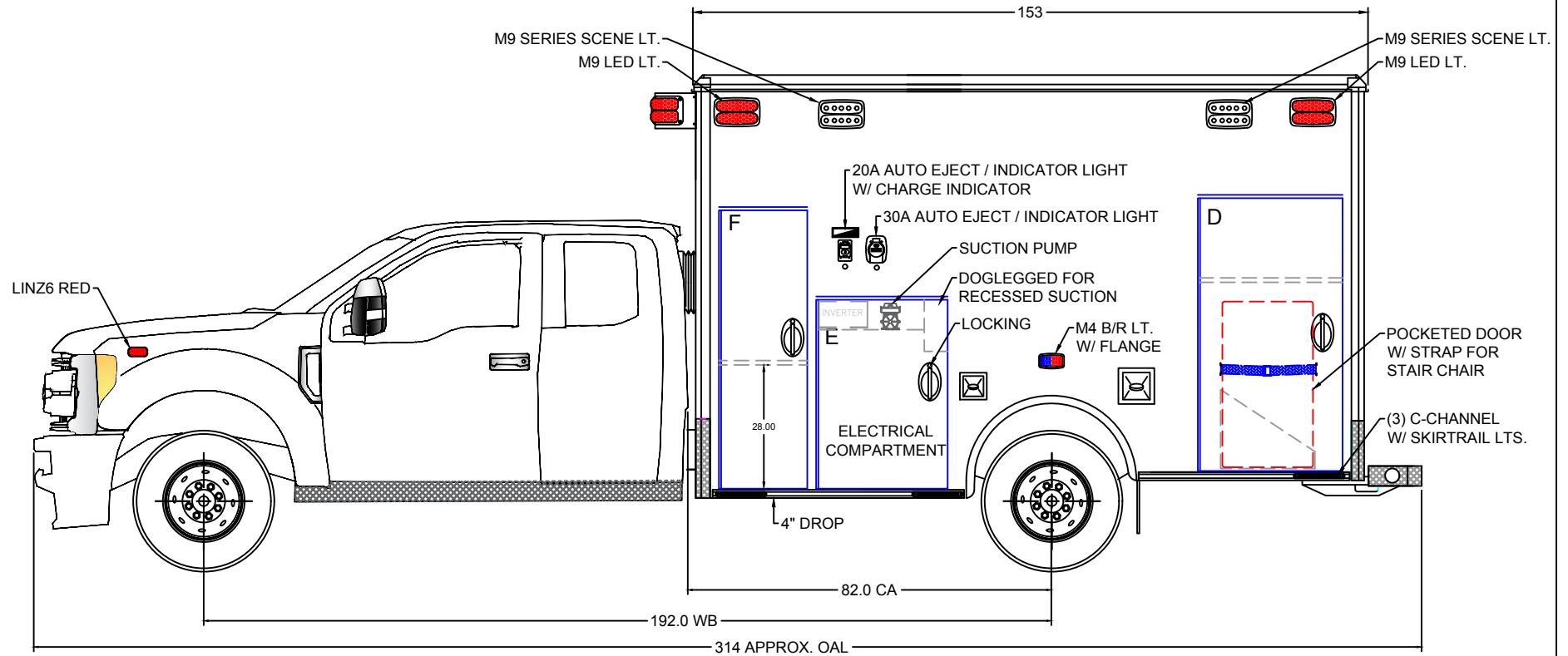

BE ADVISED THAT THESE ARE PRELIMINARY LAYOUTS INTENDED TO ILLUSTRATE DESIGN INTENT AND DIMENSIONS ARE FOR REFERENCE ONLY PRIOR TO FINAL ENGINEERING

EXTERIOR COMPARTMENT DIMENSIONS IN INCHES											
INTERIOR DIMENSIONS				JAMB OPENING		INTERIOR DIMENSIONS				JAMB OPENING	
COMPT.	HEIGHT	WIDTH	DEPTH	HEIGHT	WIDTH	COMPT.	HEIGHT	WIDTH	DEPTH	HEIGHT	WIDTH
D	61.50	32.75	12.00	58.75	29.50						
E	42.75	32.25	12.00	41.00	30.00						
F	63.00	19.25	12.00	62.50	16.75						
55" AISLE											



F450 TYPE 1 FORD 2018

LEFT EXT. VIEW

DATE 08/21/18 SCALE
 DRAWN BY SG DWG NO 2 / 9

CA164753

HARRIS ESD

153 x 95 x 72

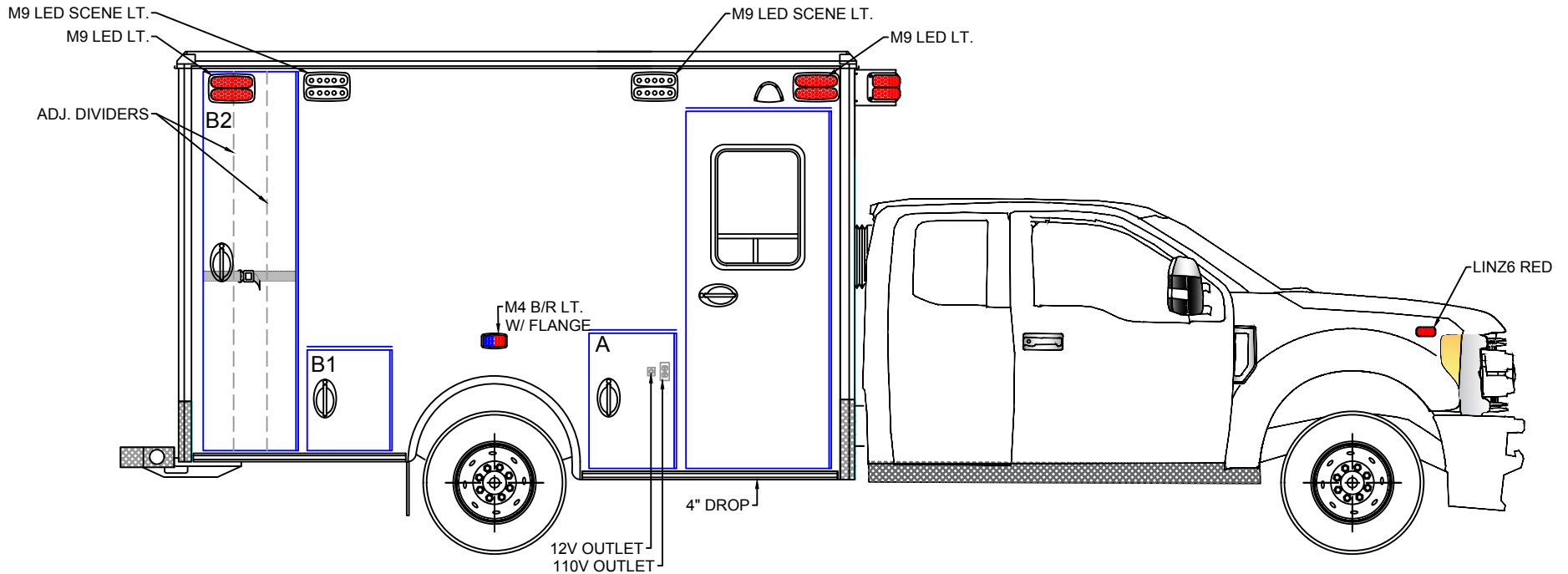

BE ADVISED THAT THESE ARE PRELIMINARY LAYOUTS INTENDED TO ILLUSTRATE DESIGN INTENT AND DIMENSIONS ARE FOR REFERENCE ONLY PRIOR TO FINAL ENGINEERING

EXTERIOR COMPARTMENT DIMENSIONS IN INCHES

INTERIOR DIMENSIONS				JAMB OPENING		INTERIOR DIMENSIONS				JAMB OPENING	
COMPT.	HEIGHT	WIDTH	DEPTH	HEIGHT	WIDTH	COMPT.	HEIGHT	WIDTH	DEPTH	HEIGHT	WIDTH
A	30.25	19.00	17.00	29.75	16.75						
B1	22.25	19.00	17.00	19.25	16.75						
B2	85.00	21.25	18.50	81.75	19.00						



F450 TYPE 1 FORD 2018

RIGHT EXT. VIEW

DATE 08/21/18

SCALE

DRAWN BY SG

DWG NO 3 / 9

55" AISLE

CA164753

HARRIS ESD

153 x 95 x 72

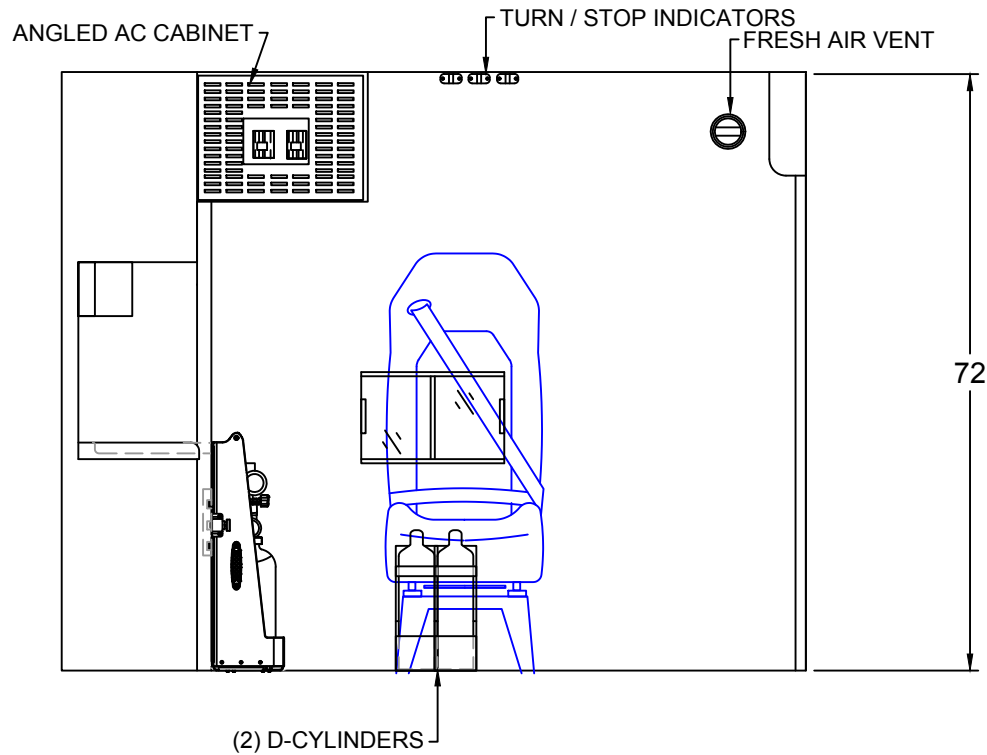

BE ADVISED THAT THESE ARE PRELIMINARY LAYOUTS INTENDED TO ILLUSTRATE DESIGN INTENT AND DIMENSIONS ARE FOR REFERENCE ONLY PRIOR TO FINAL ENGINEERING

CABINET WEIGHT RATINGS:
NON-RESTOCKING = 40 LBS.
RESTOCKING = 30 LBS.

INTERIOR CABINET DIMENSIONS IN INCHES

CABINET	HEIGHT	WIDTH	DEPTH	CABINET	HEIGHT	WIDTH	DEPTH



F450 TYPE 1 FORD 2018
BULKHEAD INTERIOR

DATE 08/21/18

SCALE

DRAWN BY SG

DWG NO 4 / 9

55" AISLE

CA164753

HARRIS ESD

153 x 95 x 72

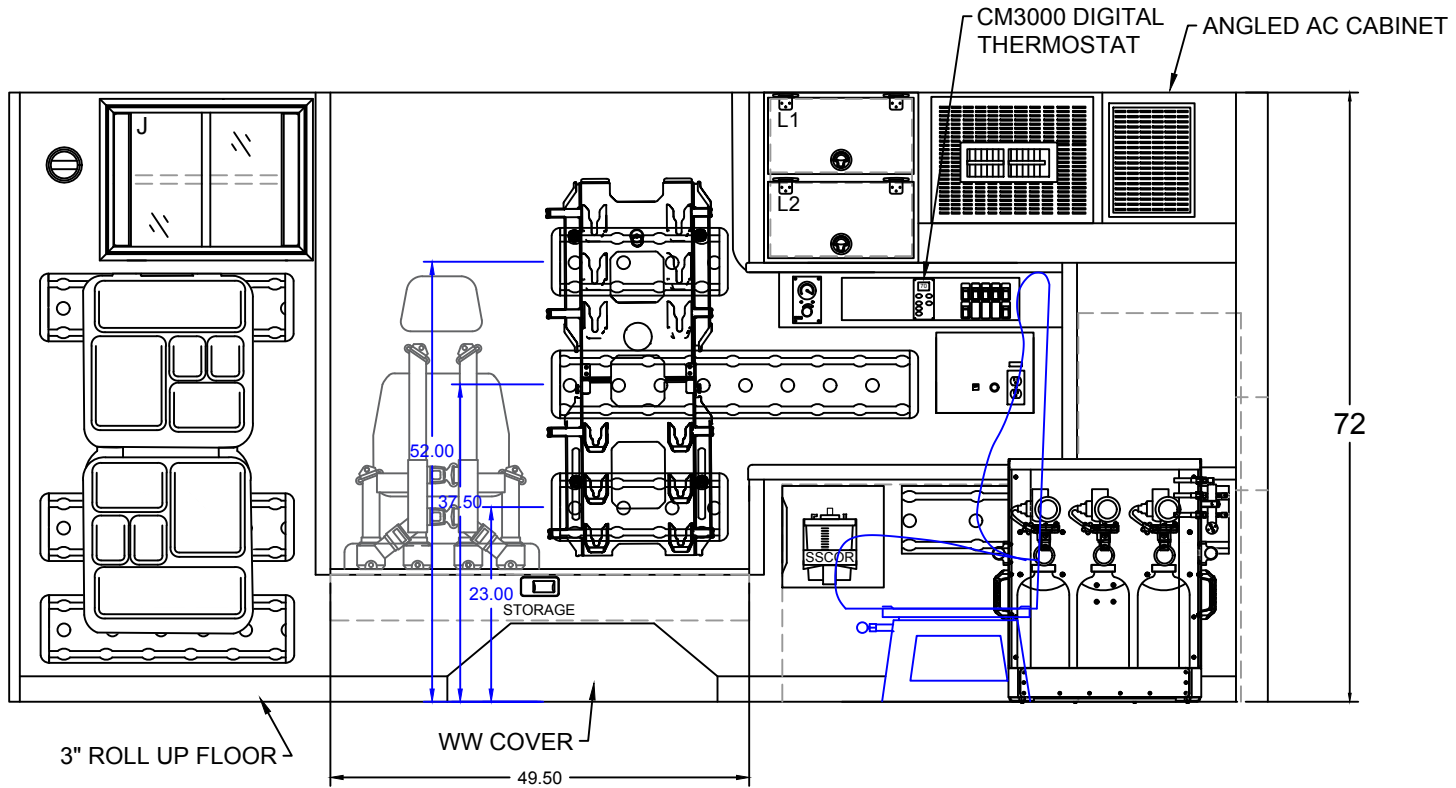

INTERIOR CABINET DIMENSIONS IN INCHES

CABINET	HEIGHT	WIDTH	DEPTH		CABINET	HEIGHT	WIDTH	DEPTH	
J	17.50	19.50	12.00						
L1	8.50	16.75	13.50						
L2	8.50	16.75	13.50						



F450 TYPE 1 FORD 2018

LEFT INTERIOR

55" AISLE

CABINET WEIGHT RATINGS:
NON-RESTOCKING = 40 LBS.
RESTOCKING = 30 LBS.

BE ADVISED THAT THESE ARE PRELIMINARY LAYOUTS INTENDED TO ILLUSTRATE DESIGN INTENT AND DIMENSIONS ARE FOR REFERENCE ONLY PRIOR TO FINAL ENGINEERING

DATE:	08/21/18	SCALE:	
DWN BY:	SG	DWG NO:	5 / 9

CA164753

HARRIS ESD

153 x 95 x 72

OUTLETS:
110V
12V
USB

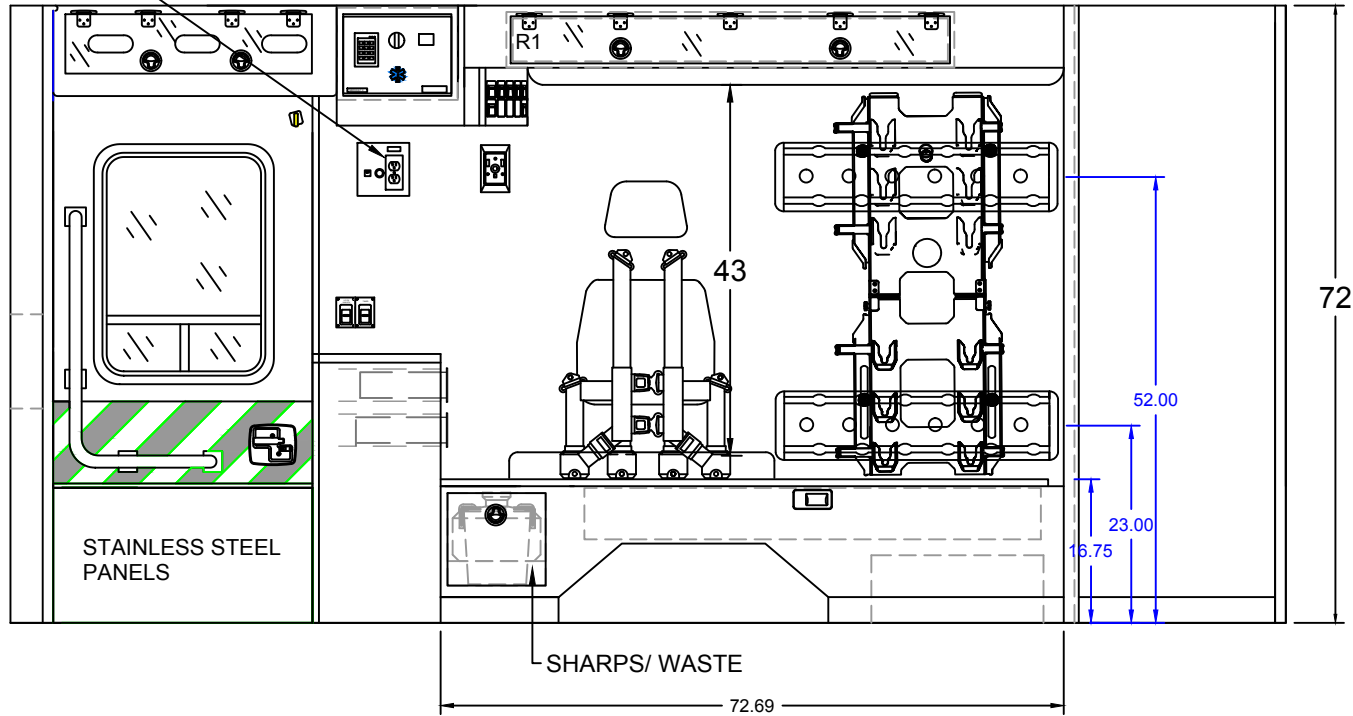

INTERIOR CABINET DIMENSIONS IN INCHES



F450 TYPE 1 FORD 2018
RIGHT INTERIOR

DATE: 08/21/18

SCALE

DWN BY

SG

DWG NO

6 / 9

COMPT.	HEIGHT	WIDTH	DEPTH		COMPT.	HEIGHT	WIDTH	DEPTH	
R1	5.00	50.00	7.00						
DRWS	3.00	10.00	12.00						
Q	6.00	53.00	16.75						

55" AISLE

CABINET WEIGHT RATINGS:
NON-RESTOCKING = 40 LBS.
RESTOCKING = 30 LBS.

BE ADVISED THAT THESE ARE PRELIMINARY LAYOUTS INTENDED TO ILLUSTRATE DESIGN INTENT AND DIMENSIONS ARE FOR REFERENCE ONLY PRIOR TO FINAL ENGINEERING

CA164753

HARRIS ESD

153 x 95 x 72

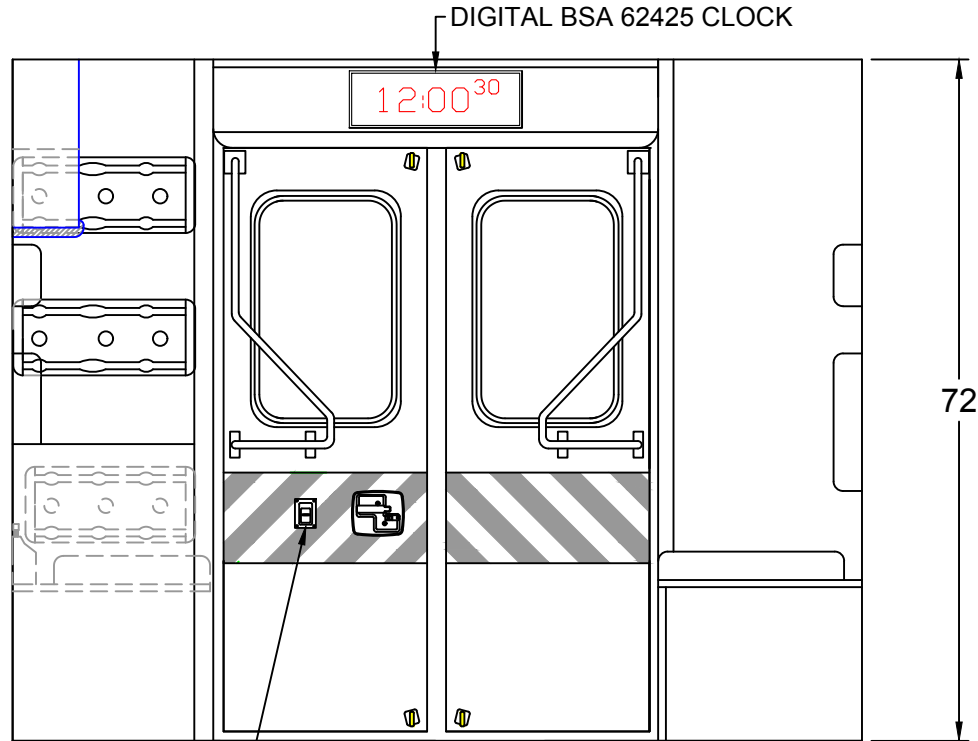

INTERIOR CABINET DIMENSIONS IN INCHES



COMPT.	HEIGHT	WIDTH	DEPTH		COMPT.	HEIGHT	WIDTH	DEPTH	

F450 TYPE 1 FORD 2018

REAR BULKHEAD INTERIOR

DATE: 08/21/18 SCALE

DWN BY: SG DWG NO: 7 / 9

55" AISLE

CABINET WEIGHT RATINGS:
NON-RESTOCKING = 40 LBS.
RESTOCKING = 30 LBS.

BE ADVISED THAT THESE ARE PRELIMINARY LAYOUTS INTENDED TO ILLUSTRATE DESIGN INTENT AND DIMENSIONS ARE FOR REFERENCE ONLY PRIOR TO FINAL ENGINEERING

CA164753

HARRIS ESD

153 x 95 x 72

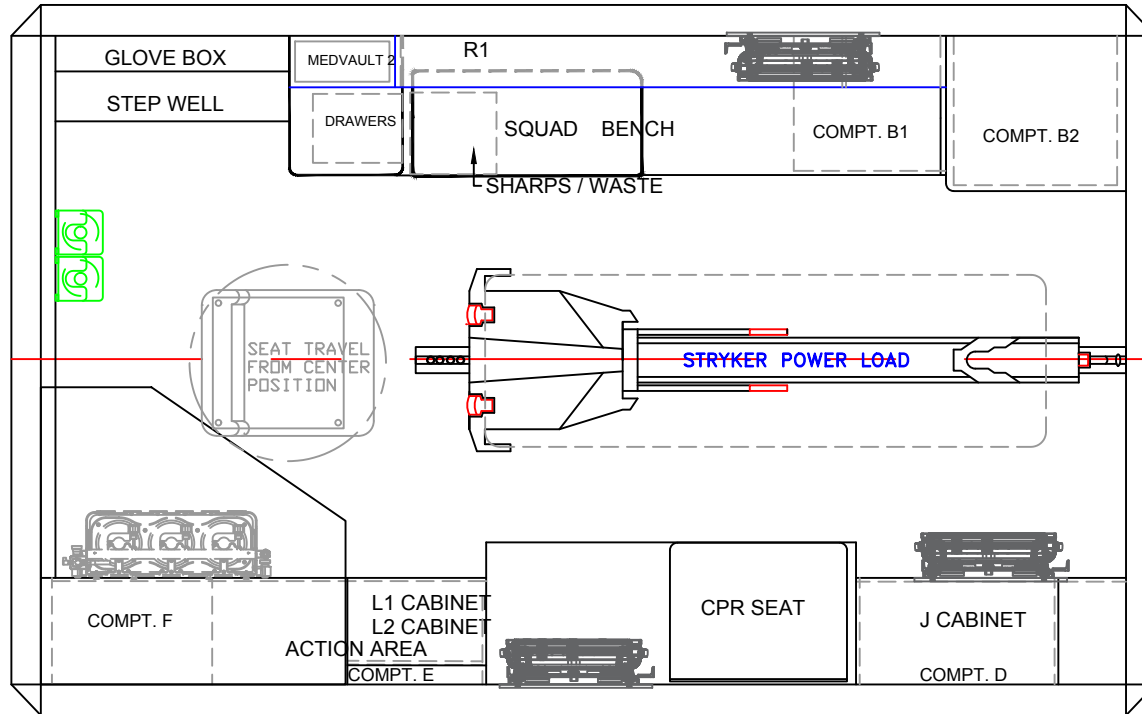

BE ADVISED THAT THESE ARE PRELIMINARY LAYOUTS INTENDED TO ILLUSTRATE DESIGN INTENT AND DIMENSIONS ARE FOR REFERENCE ONLY PRIOR TO FINAL ENGINEERING

INTERIOR CABINET DIMENSIONS IN INCHES

CABINET	HEIGHT	WIDTH	DEPTH	CABINET	HEIGHT	WIDTH	DEPTH



F450 TYPE 1 FORD 2018
FLOOR PLAN

DATE: 08/21/18 SCALE
OWN BY: SG DWG NO: 8 / 9

55" AISLE

CA164753

HARRIS ESD

153 x 95 x 72

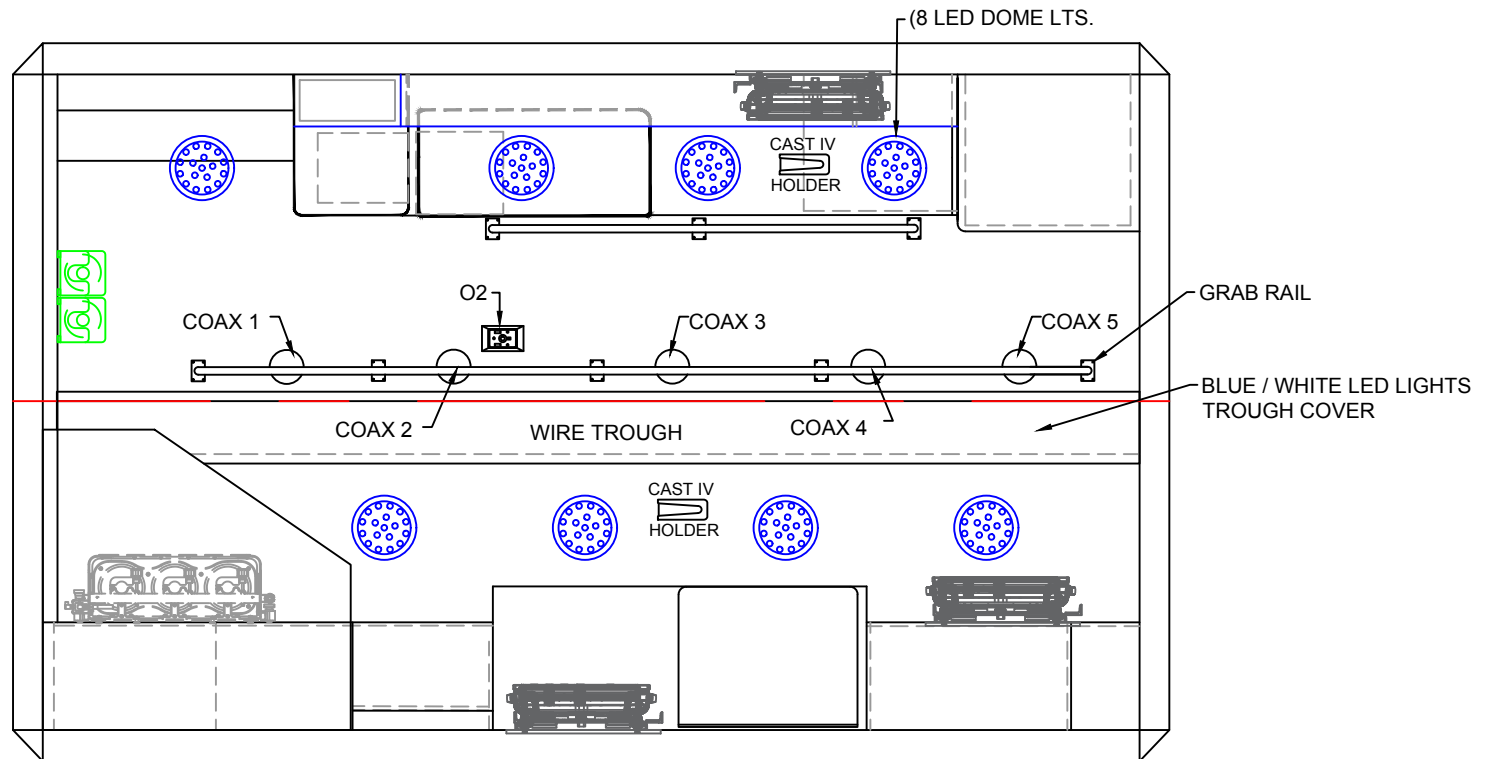

BE ADVISED THAT THESE ARE PRELIMINARY LAYOUTS INTENDED TO ILLUSTRATE DESIGN INTENT AND DIMENSIONS ARE FOR REFERENCE ONLY PRIOR TO FINAL ENGINEERING

INTERIOR CABINET DIMENSIONS IN INCHES

CABINET	HEIGHT	WIDTH	DEPTH	CABINET	HEIGHT	WIDTH	DEPTH



F450 TYPE 1 FORD 2018

LINER

DATE: 08/21/18

SCALE

DWN BY: SG

DWG NO: 9 / 9

55" AISLE