

CA165052

NORTHWEST EMS

153 x 98 x 72

ALL WARNING LIGHTS TO HAVE CLEAR LENS

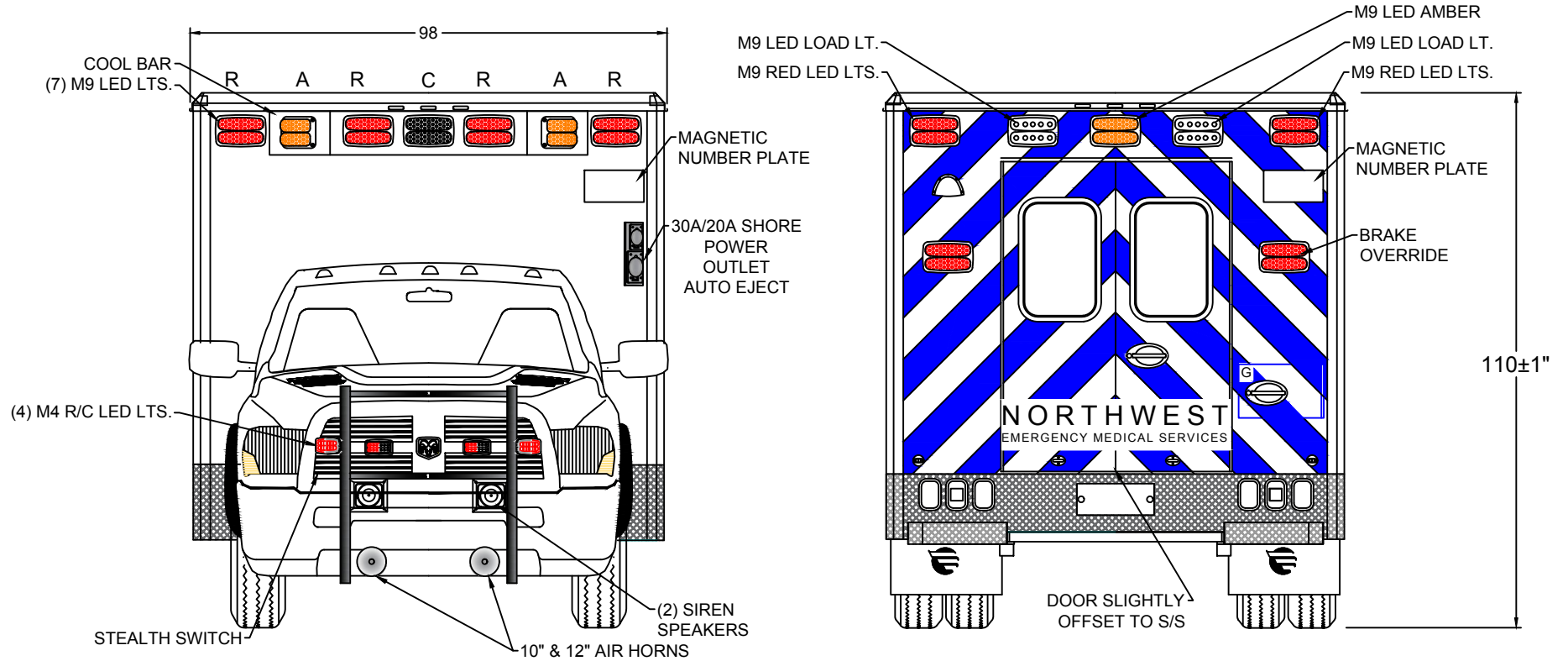

EXTERIOR COMPARTMENT DIMENSIONS IN INCHES

INTERIOR DIMENSIONS				PASS THRU		INTERIOR DIMENSIONS				JAMB OPENING	
COMPT.	HEIGHT	WIDTH	DEPTH	HEIGHT	WIDTH	COMPT.	HEIGHT	WIDTH	DEPTH	HEIGHT	WIDTH
G	8.50	24.00	82.50	10.50	19.00						



4500 TYPE I DODGE 2019
FRONT / REAR
EXTERIOR VIEWS

BE ADVISED THAT THESE ARE PRELIMINARY LAYOUTS INTENDED TO ILLUSTRATE DESIGN INTENT AND DIMENSIONS ARE FOR REFERENCE ONLY PRIOR TO FINAL ENGINEERING

DATE:	10/22/18	SCALE
DWN BY:	AP	DWG NO
		1 / 9

CA165052

NORTHWEST EMS

153 x 98 x 72

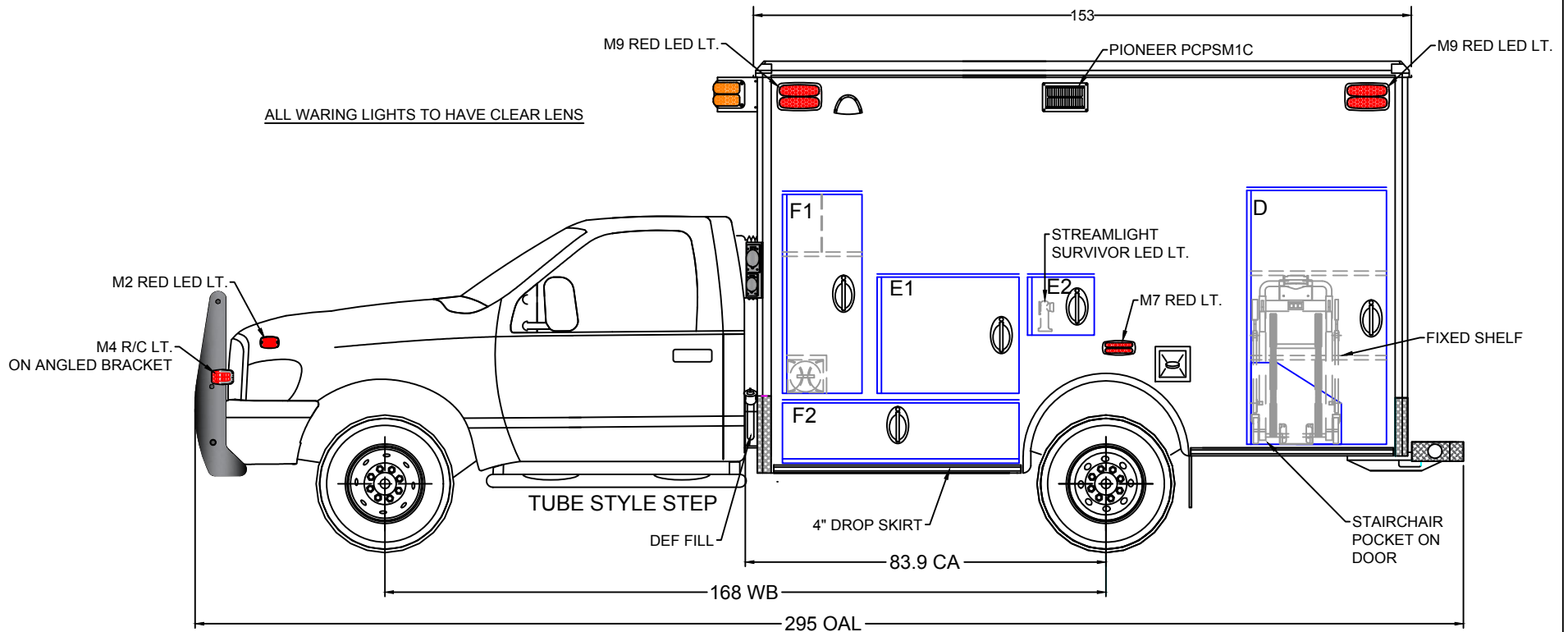

BE ADVISED THAT THESE ARE PRELIMINARY LAYOUTS INTENDED TO ILLUSTRATE DESIGN INTENT AND DIMENSIONS ARE FOR REFERENCE ONLY PRIOR TO FINAL ENGINEERING

EXTERIOR COMPARTMENT DIMENSIONS IN INCHES												 4500 TYPE I DODGE 2019 LEFT EXT. VIEW	
INTERIOR DIMENSIONS				JAMB OPENING		INTERIOR DIMENSIONS				JAMB OPENING			
COMPT.	HEIGHT	WIDTH	DEPTH	HEIGHT	WIDTH	COMPT.	HEIGHT	WIDTH	DEPTH	HEIGHT	WIDTH		
F1	46.25	19.25	22.00	45.75	17.00	D	59.00	32.75	20.50	58.50	29.50		
F2	14.00	55.00	21.00	11.25	51.50								
E1	27.00	33.00	20.50	26.50	30.75								
E2	13.50	15.50	20.50	13.00	13.00								
										DATE	10/22/18	SCALE	
										DRAWN BY	AP	DWG NO	2 / 9

CA165052

NORTHWEST EMS

153 x 98 x 72

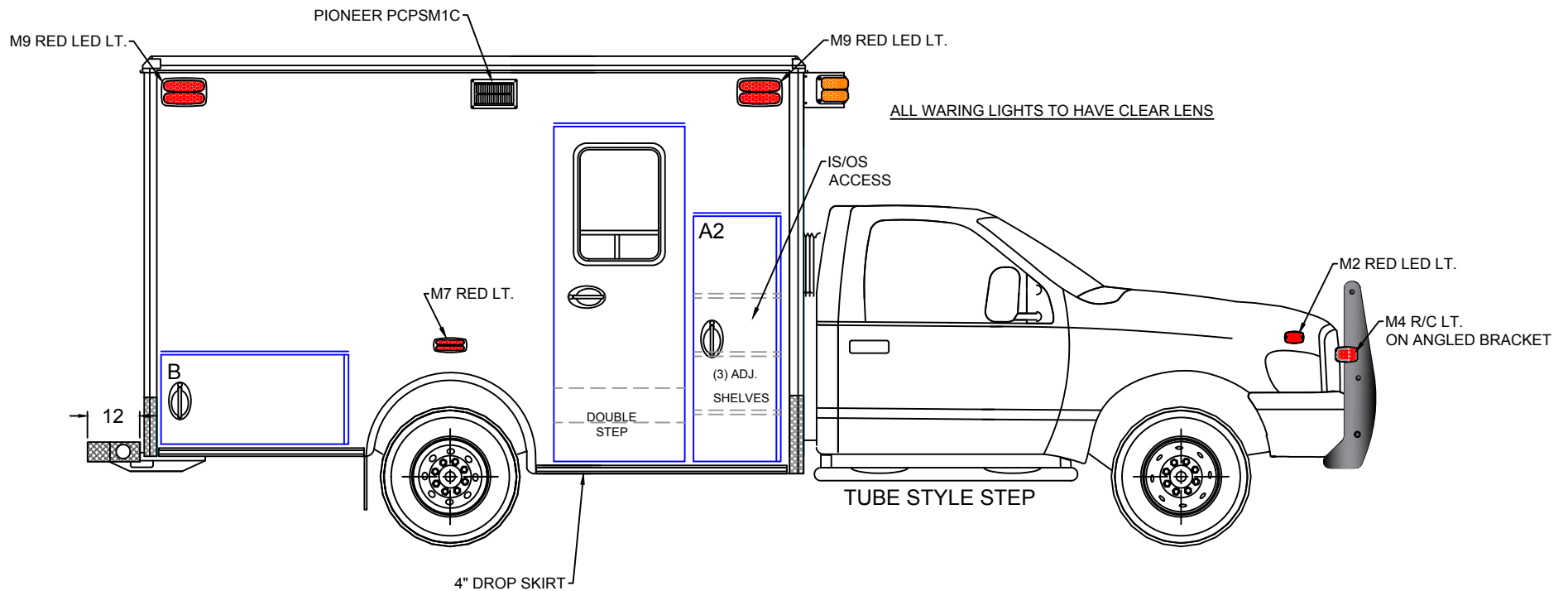

BE ADVISED THAT THESE ARE PRELIMINARY LAYOUTS INTENDED TO ILLUSTRATE DESIGN INTENT AND DIMENSIONS ARE FOR REFERENCE ONLY PRIOR TO FINAL ENGINEERING

EXTERIOR COMPARTMENT DIMENSIONS IN INCHES

INTERIOR DIMENSIONS				JAMB OPENING		INTERIOR DIMENSIONS				JAMB OPENING	
COMPT.	HEIGHT	WIDTH	DEPTH	HEIGHT	WIDTH	COMPT.	HEIGHT	WIDTH	DEPTH	HEIGHT	WIDTH
A	56.50	20.00	30.25	56.00	17.75						
B	20.50	43.00	22.00	19.75	39.50						



4500 TYPE I DODGE 2019

RIGHT EXT. VIEW

DATE 10/22/18

SCALE

DRAWN BY AP

DWG NO 3 / 9

CA165052

NORTHWEST EMS

153 x 98 x 72

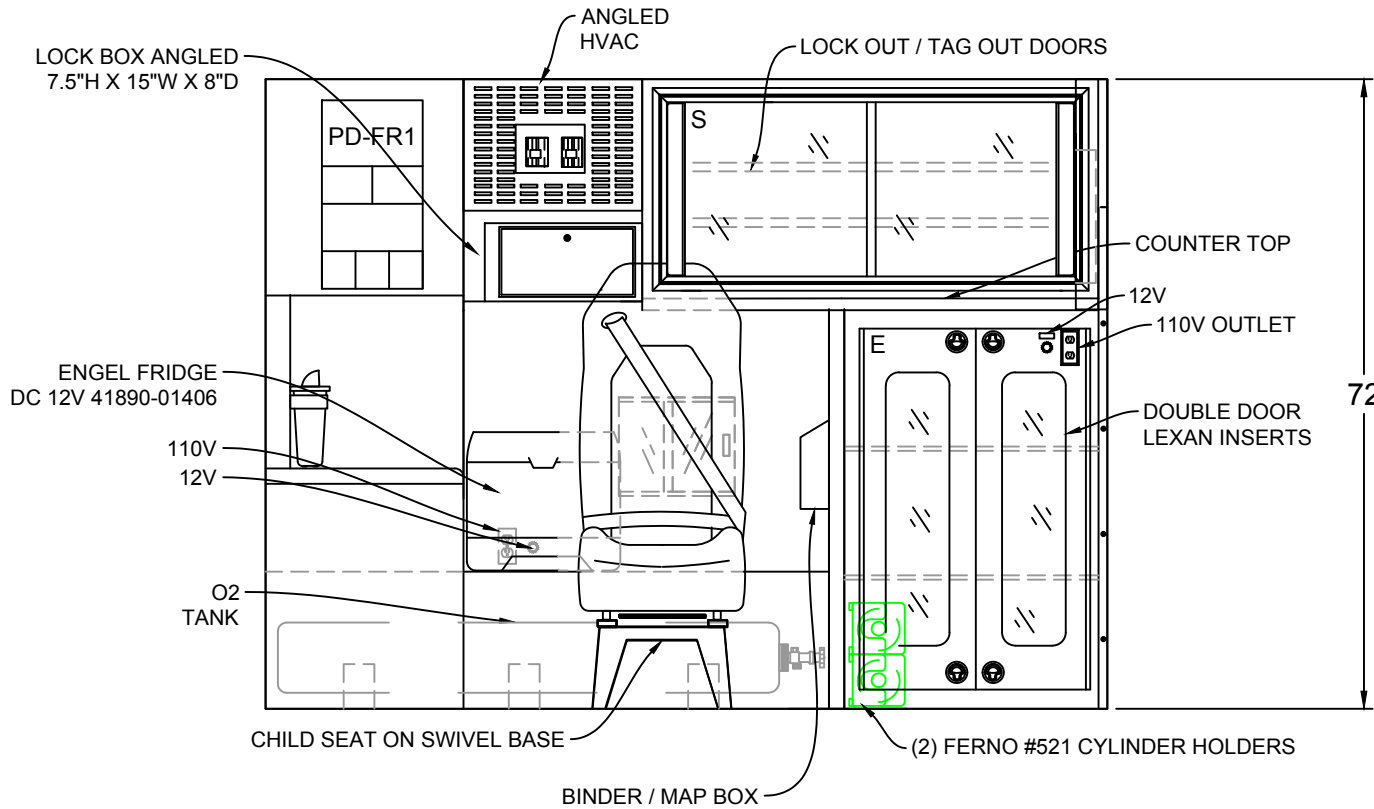

BE ADVISED THAT THESE ARE PRELIMINARY LAYOUTS INTENDED TO ILLUSTRATE DESIGN INTENT AND DIMENSIONS ARE FOR REFERENCE ONLY PRIOR TO FINAL ENGINEERING

INTERIOR CABINET DIMENSIONS IN INCHES									
CABINET	HEIGHT	WIDTH	DEPTH	CABINET	HEIGHT	WIDTH	DEPTH		
S	29.00	52.00	14.00					4500 TYPE I DODGE 2019 BULKHEAD INTERIOR	
E1	39.00	33.50	20.75						
								DATE 10/22/18	SCALE
								DRAWN BY AP	DWG NO 4 / 9

CA165052

NORTHWEST EMS

153 x 98 x 72

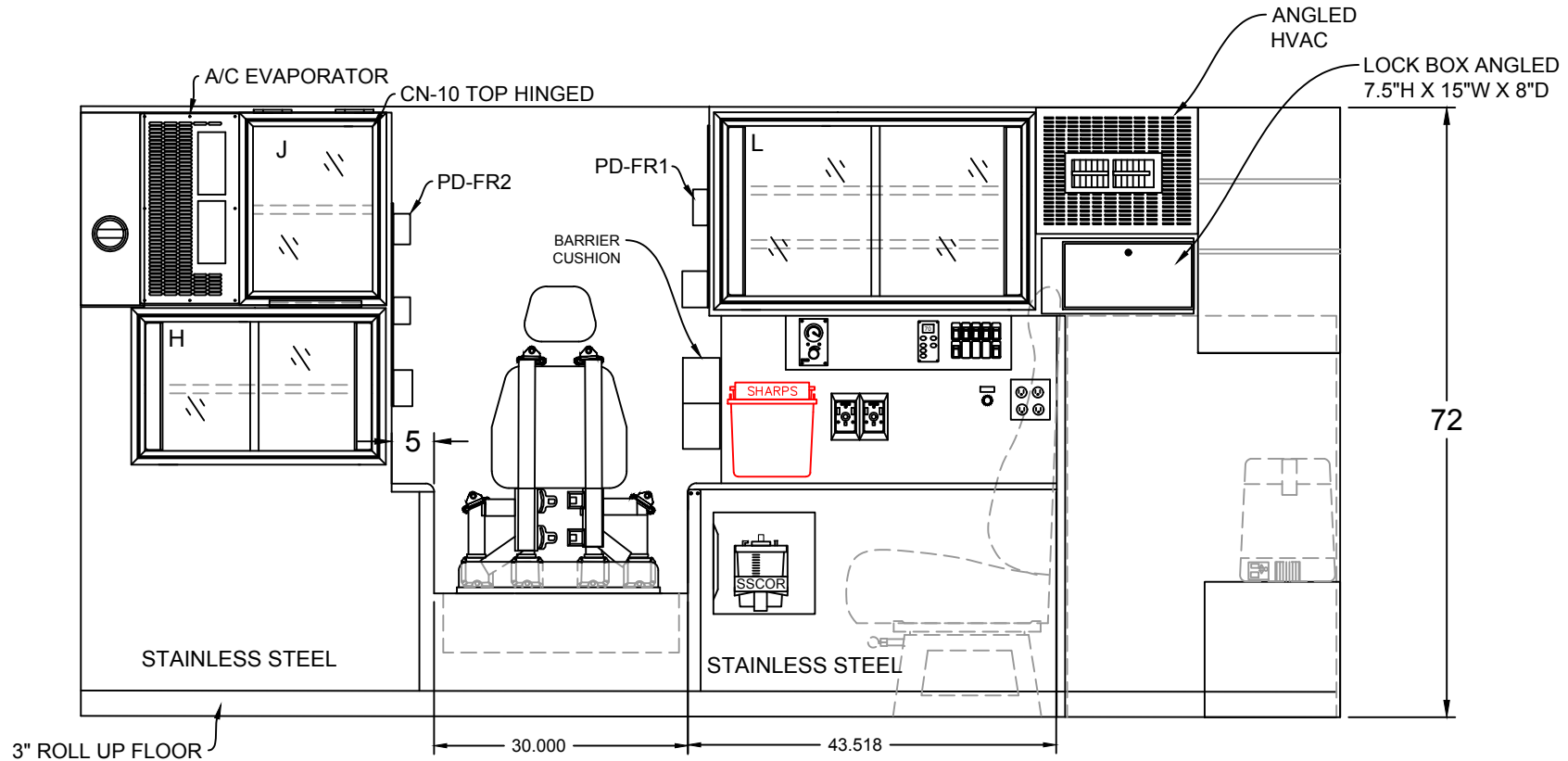

INTERIOR CABINET DIMENSIONS IN INCHES

CABINET	HEIGHT	WIDTH	DEPTH		CABINET	HEIGHT	WIDTH	DEPTH	
J	22.00	16.00	20.50						
H	18.50	30.00	IS/OS						
L	22.00	38.00	20.50						



4500 TYPE I DODGE 2019
LEFT INTERIOR

DATE: 10/22/18 SCALE:
DWN BY: AP DWG NO: 5 / 9

BE ADVISED THAT THESE ARE PRELIMINARY LAYOUTS INTENDED TO ILLUSTRATE DESIGN INTENT AND DIMENSIONS ARE FOR REFERENCE ONLY PRIOR TO FINAL ENGINEERING

CA165052

NORTHWEST EMS

153 x 98 x 72

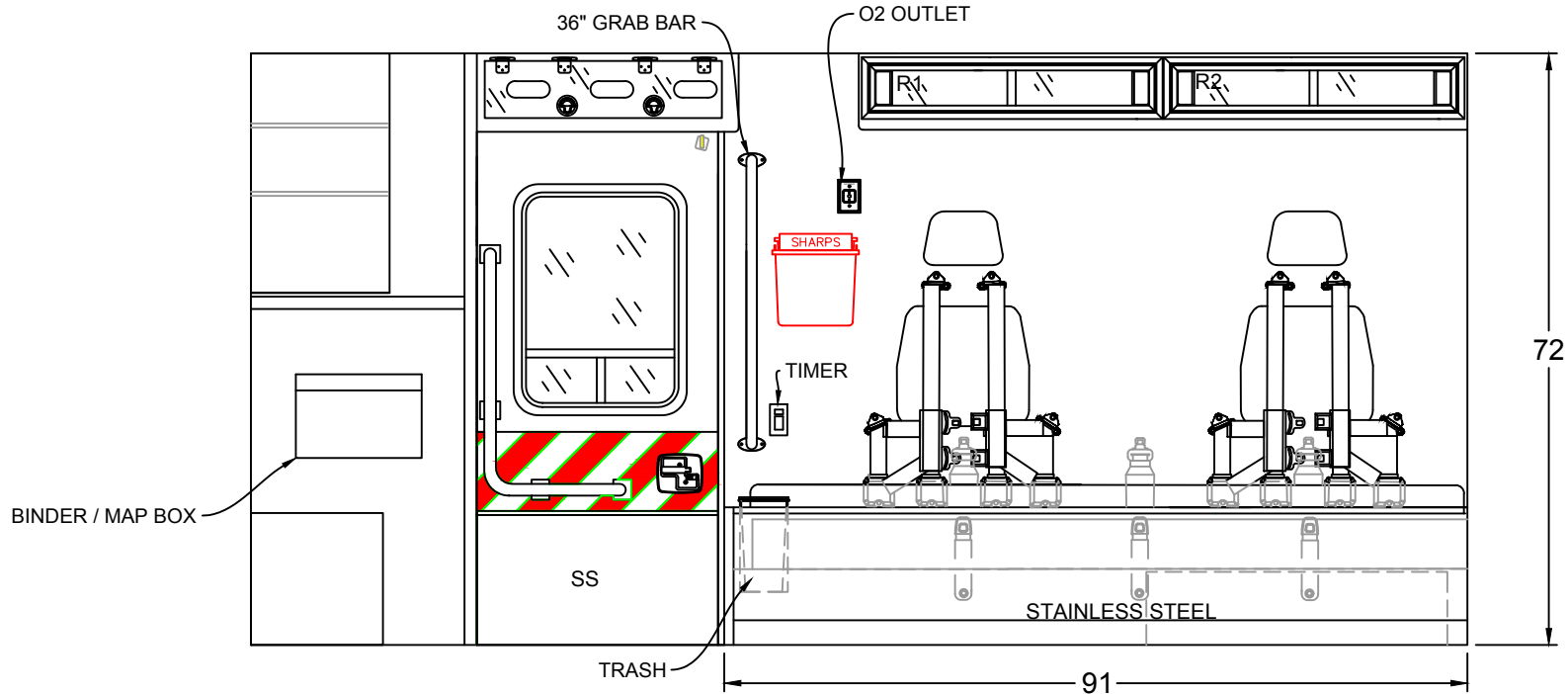

INTERIOR CABINET DIMENSIONS IN INCHES

COMPT.	HEIGHT	WIDTH	DEPTH		COMPT.	HEIGHT	WIDTH	DEPTH	
E	19.00	26.50	12.00						
R1	8.00	31.00	9.00						
R2	8.00	31.00	9.00						



4500 TYPE I DODGE 2019
RIGHT INTERIOR

DATE: 10/22/18 SCALE
DWN BY: AP DWG NO: 6 / 9

BE ADVISED THAT THESE ARE PRELIMINARY LAYOUTS INTENDED TO ILLUSTRATE DESIGN INTENT AND DIMENSIONS ARE FOR REFERENCE ONLY PRIOR TO FINAL ENGINEERING

CA165052

NORTHWEST EMS

153 x 98 x 72

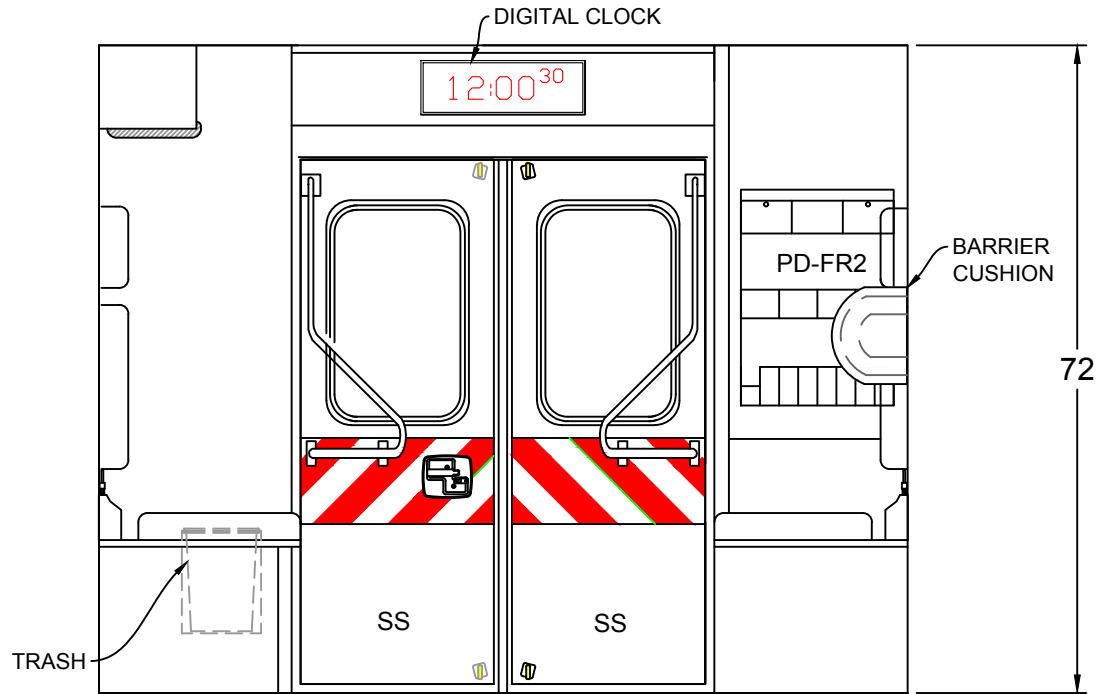

INTERIOR CABINET DIMENSIONS IN INCHES



COMPT.	HEIGHT	WIDTH	DEPTH	COMPT.	HEIGHT	WIDTH	DEPTH

4500 TYPE I DODGE 2019
 REAR BULKHEAD INTERIOR

DATE: 10/22/18 SCALE

DWG BY: AP DWG NO: 7 / 9

BE ADVISED THAT THESE ARE PRELIMINARY LAYOUTS INTENDED TO ILLUSTRATE DESIGN INTENT AND DIMENSIONS ARE FOR REFERENCE ONLY PRIOR TO FINAL ENGINEERING

CA165052

NORTHWEST EMS

153 x 98 x 72

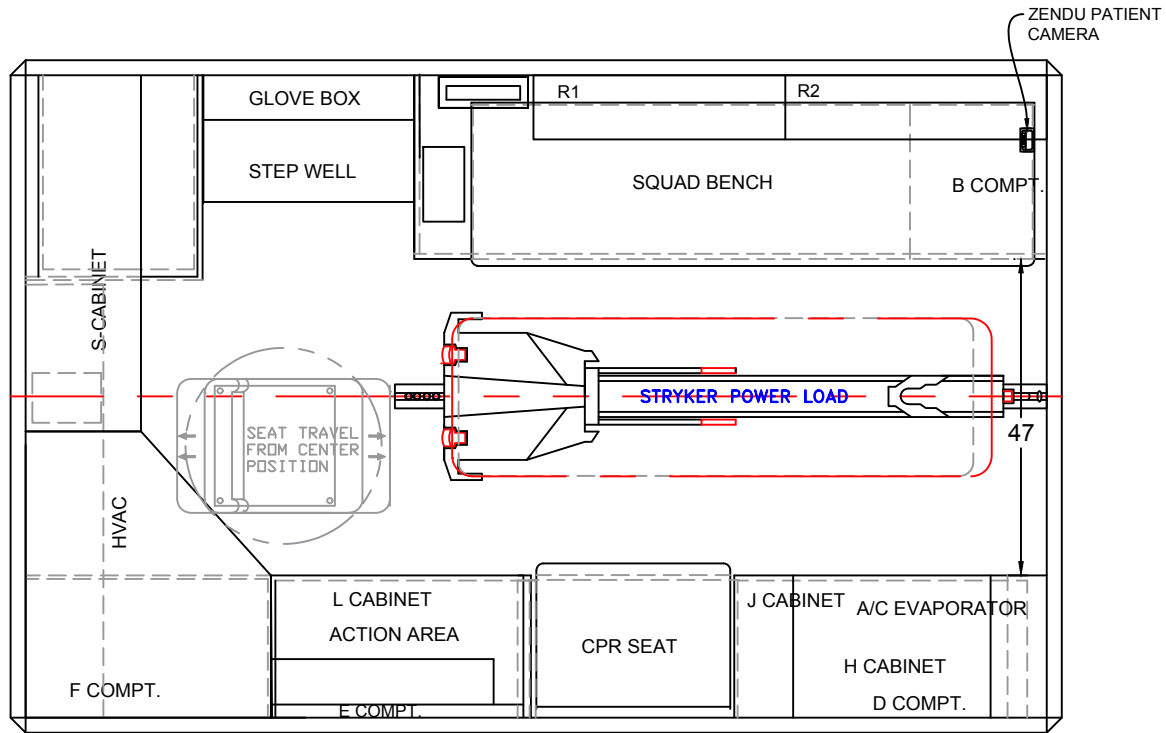

BE ADVISED THAT THESE ARE PRELIMINARY LAYOUTS INTENDED TO ILLUSTRATE DESIGN INTENT AND DIMENSIONS ARE FOR REFERENCE ONLY PRIOR TO FINAL ENGINEERING

INTERIOR CABINET DIMENSIONS IN INCHES							
CABINET	HEIGHT	WIDTH	DEPTH	CABINET	HEIGHT	WIDTH	DEPTH



4500 TYPE I DODGE 2019
FLOOR PLAN

DATE:	10/22/18	SCALE:	
DWN BY:	AP	DWG NO:	8 / 9

CA165052

NORTHWEST EMS

153 x 98 x 72

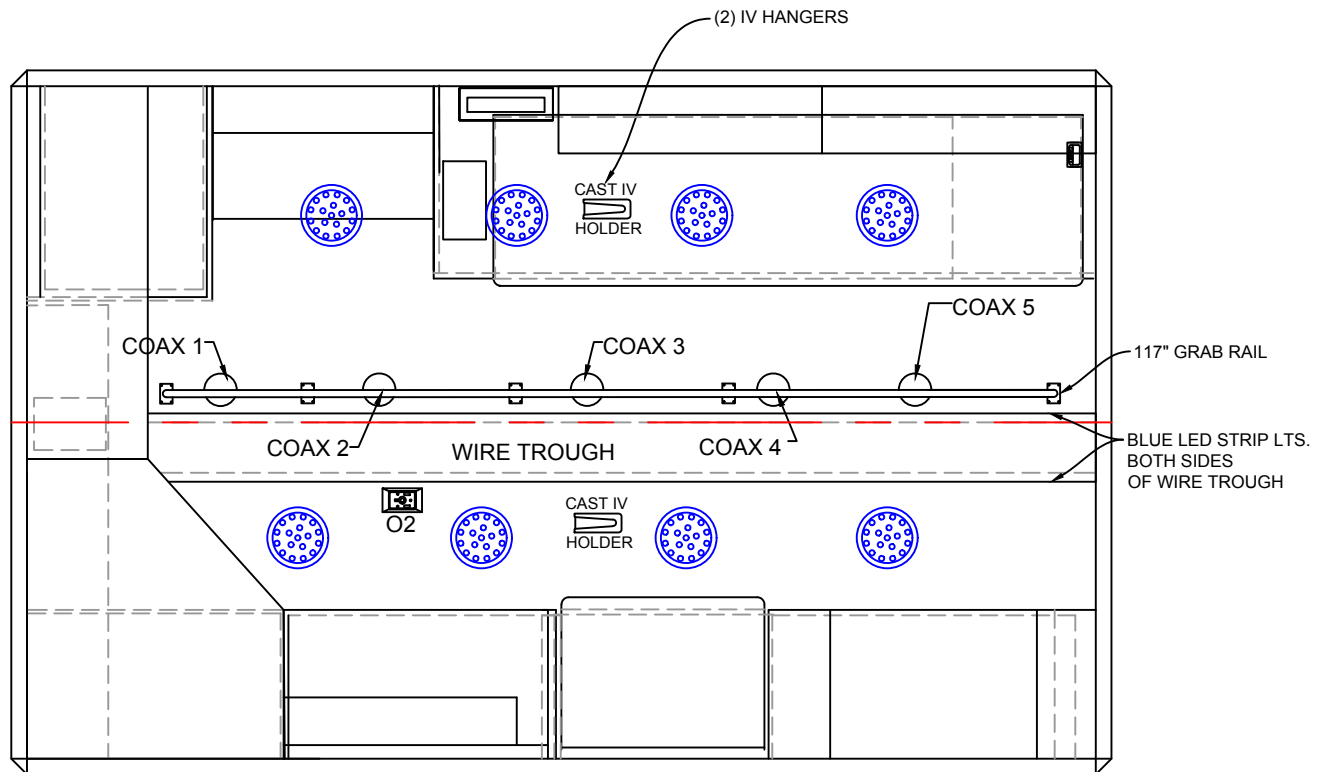

BE ADVISED THAT THESE ARE PRELIMINARY LAYOUTS INTENDED TO ILLUSTRATE DESIGN INTENT AND DIMENSIONS ARE FOR REFERENCE ONLY PRIOR TO FINAL ENGINEERING

INTERIOR CABINET DIMENSIONS IN INCHES

CABINET	HEIGHT	WIDTH	DEPTH	CABINET	HEIGHT	WIDTH	DEPTH



4500 TYPE I DODGE 2019
LINER

DATE:	10/22/18	SCALE:	
DWN BY:	AP	DWG NO:	9 / 9