

CA165462

BRAZORIA COUNTY ESD 3

153 x 98 x 72

ALL WARNING LIGHTS TO HAVE CLEAR LENS

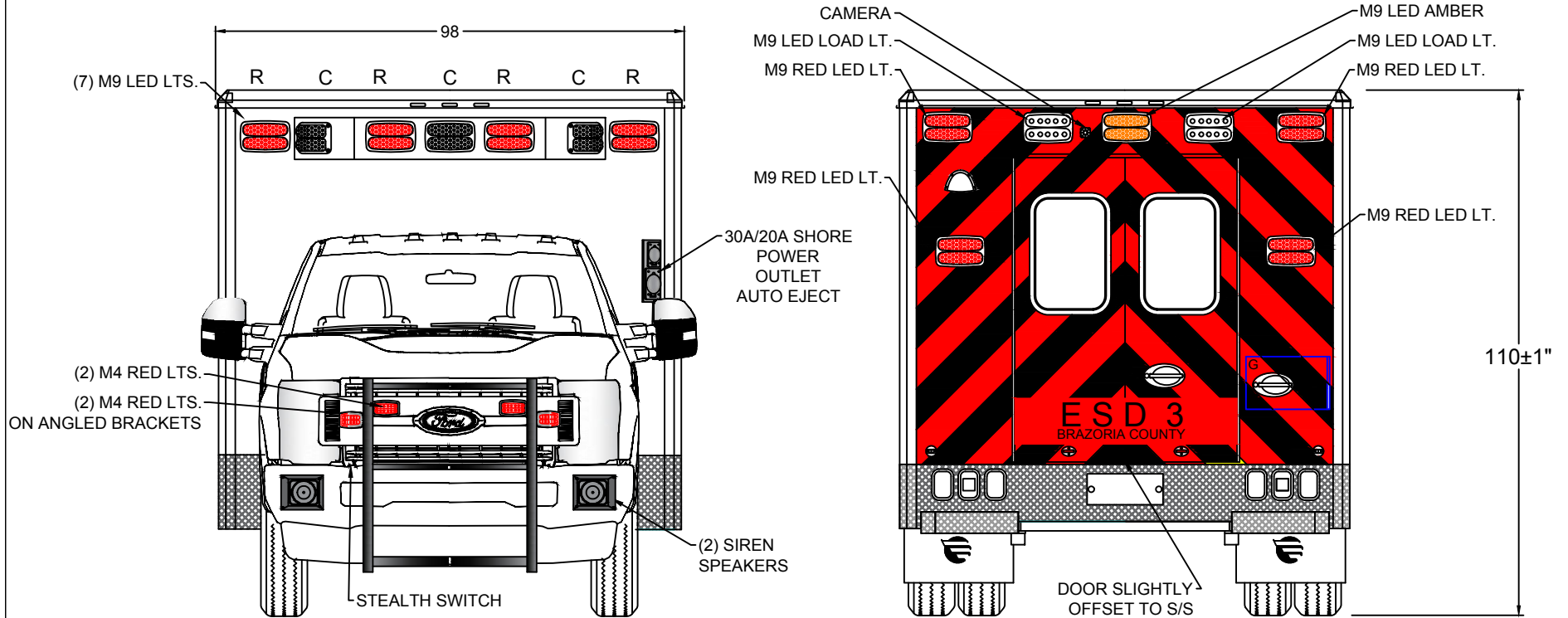

EXTERIOR COMPARTMENT DIMENSIONS IN INCHES

INTERIOR DIMENSIONS				PASS THRU		INTERIOR DIMENSIONS				JAMB OPENING	
COMPT.	HEIGHT	WIDTH	DEPTH	HEIGHT	WIDTH	COMPT.	HEIGHT	WIDTH	DEPTH	HEIGHT	WIDTH
G	8.50	22.75	78.25	10.50	19.00						



F450 TYPE I FORD 2019
FRONT / REAR
EXTERIOR VIEWS

BE ADVISED THAT THESE ARE PRELIMINARY LAYOUTS INTENDED TO ILLUSTRATE DESIGN INTENT AND DIMENSIONS ARE FOR REFERENCE ONLY PRIOR TO FINAL ENGINEERING

DATE:	1/29/20	SCALE
DWN BY:	AP	DWG NO 1 / 9

CA165462

BRAZORIA COUNTY ESD 3

153 x 98 x 72

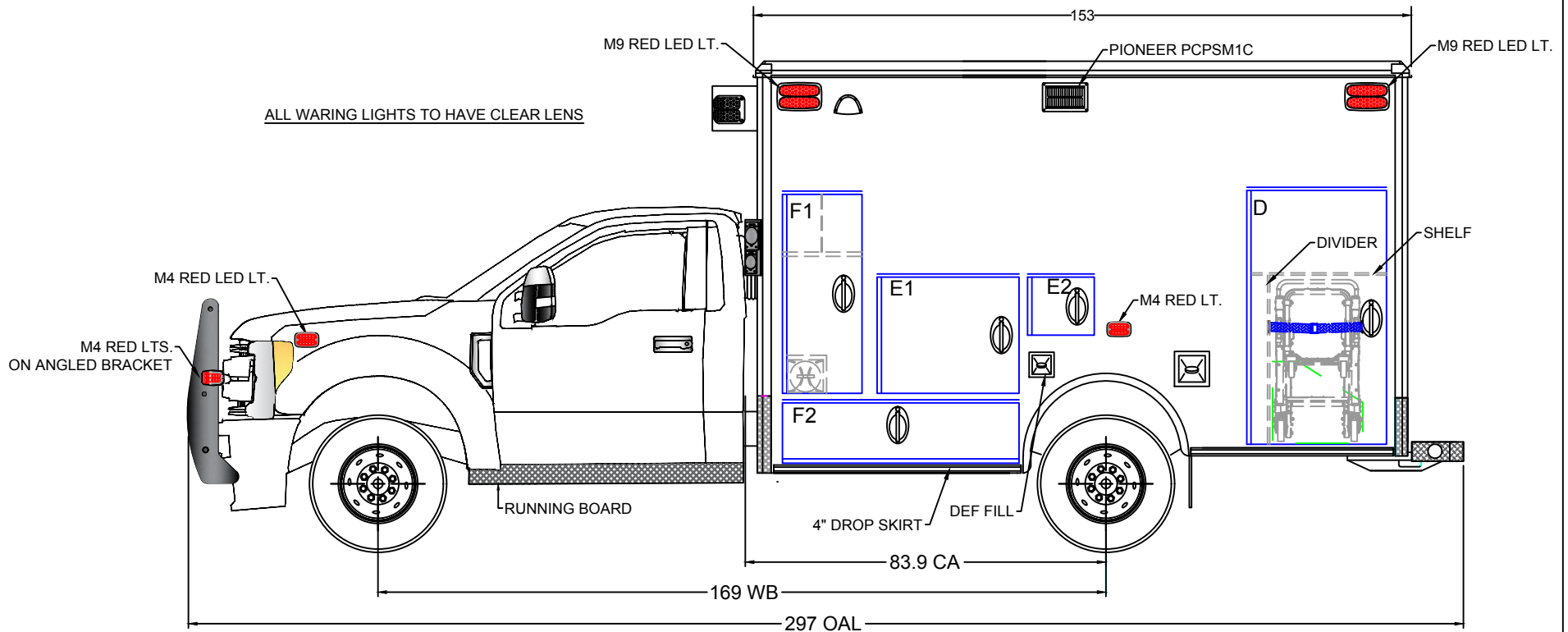

BE ADVISED THAT THESE ARE PRELIMINARY LAYOUTS INTENDED TO ILLUSTRATE DESIGN INTENT AND DIMENSIONS ARE FOR REFERENCE ONLY PRIOR TO FINAL ENGINEERING

EXTERIOR COMPARTMENT DIMENSIONS IN INCHES

INTERIOR DIMENSIONS				JAMB OPENING		INTERIOR DIMENSIONS				JAMB OPENING	
COMPT.	HEIGHT	WIDTH	DEPTH	HEIGHT	WIDTH	COMPT.	HEIGHT	WIDTH	DEPTH	HEIGHT	WIDTH
F1	46.25	19.25	21.75	45.75	17.00	D	59.00	32.75	20.50	58.50	29.50
F2	14.00	55.00	20.75	11.25	51.50						
E1	27.00	33.00	20.50	26.50	30.75						
E2	13.50	15.50	12.00	13.00	13.00						



F450 TYPE I FORD 2019

LEFT EXT. VIEW

DATE	1/29/20	SCALE	
DRAWN BY	AP	DWG NO	2 / 9

CA165462

BRAZORIA COUNTY ESD 3

153 x 98 x 72

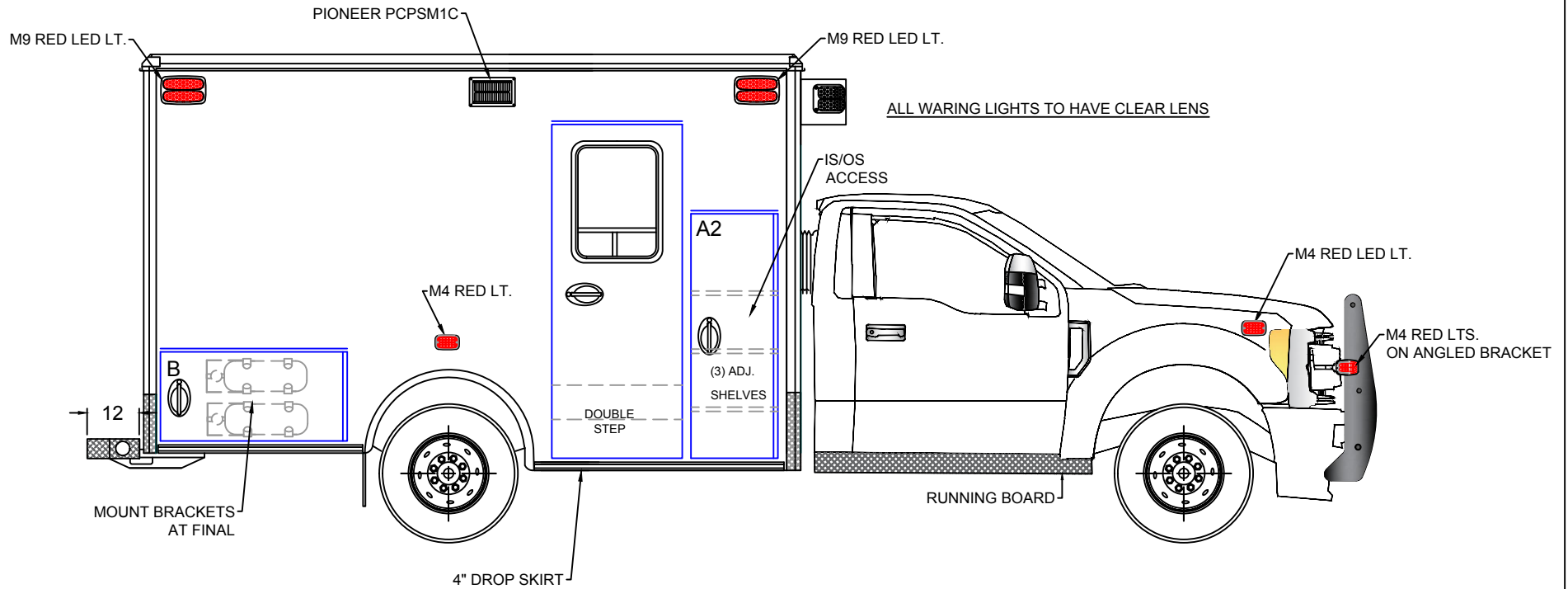

BE ADVISED THAT THESE ARE PRELIMINARY LAYOUTS INTENDED TO ILLUSTRATE DESIGN INTENT AND DIMENSIONS ARE FOR REFERENCE ONLY PRIOR TO FINAL ENGINEERING

EXTERIOR COMPARTMENT DIMENSIONS IN INCHES

INTERIOR DIMENSIONS				JAMB OPENING		INTERIOR DIMENSIONS				JAMB OPENING	
COMPT.	HEIGHT	WIDTH	DEPTH	HEIGHT	WIDTH	COMPT.	HEIGHT	WIDTH	DEPTH	HEIGHT	WIDTH
A				56.00	17.75						
LOWER-A	14.75	20.00	21.00								
B	20.50	43.00	22.00	19.75	39.50						



F450 TYPE I FORD 2019

RIGHT EXT. VIEW

DATE 1/29/20

SCALE

DRAWN BY AP

DWG NO 3 / 9

CA165462

BRAZORIA COUNTY ESD 3

153 x 98 x 72

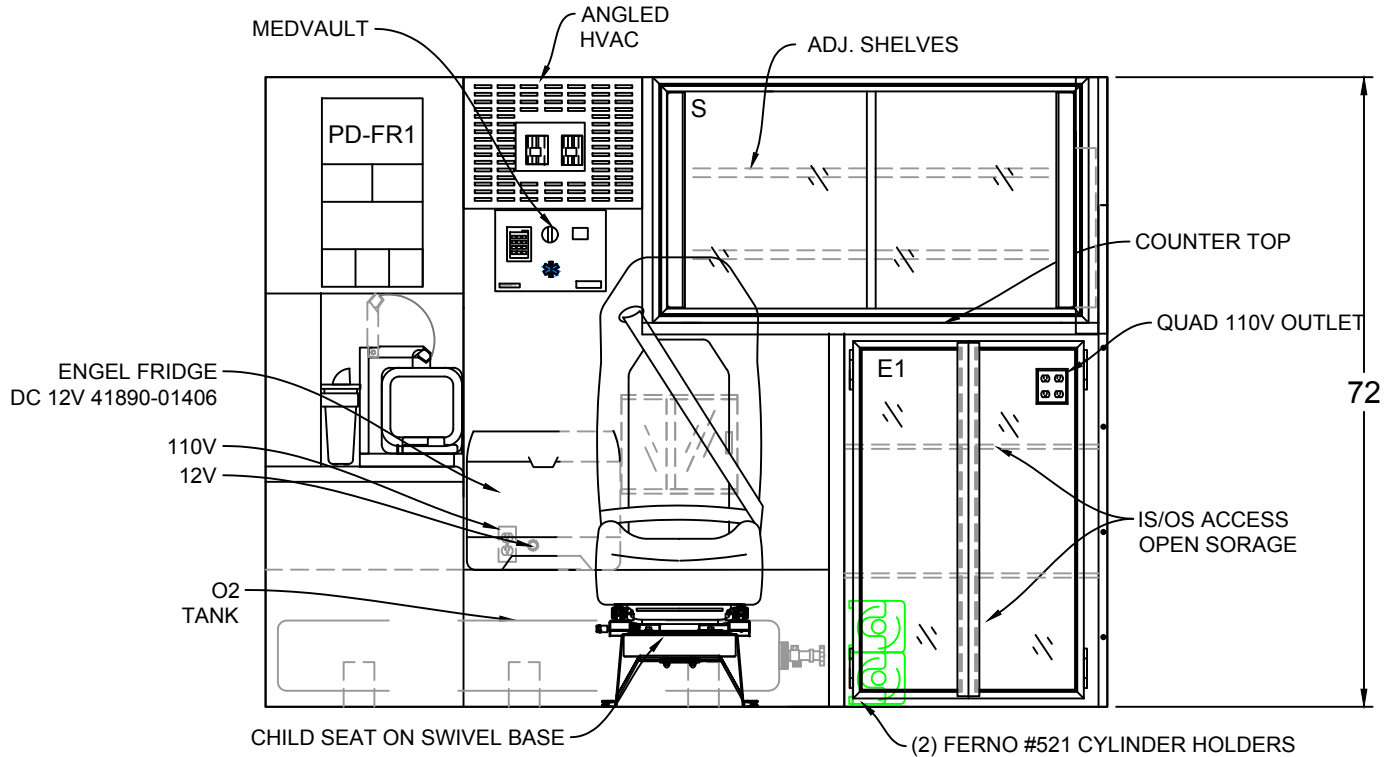

BE ADVISED THAT THESE ARE PRELIMINARY LAYOUTS INTENDED TO ILLUSTRATE DESIGN INTENT AND DIMENSIONS ARE FOR REFERENCE ONLY PRIOR TO FINAL ENGINEERING

INTERIOR CABINET DIMENSIONS IN INCHES								
CABINET	HEIGHT	WIDTH	DEPTH	CABINET	HEIGHT	WIDTH	DEPTH	
S	29.00	52.50	14.00					F450 TYPE I FORD 2019 BULKHEAD INTERIOR
E1	39.00	33.50	20.75					
								DATE 1/29/20 SCALE
								DRAWN BY AP DWG NO 4 / 9

CA165462

BRAZORIA COUNTY ESD 3

153 x 98 x 72

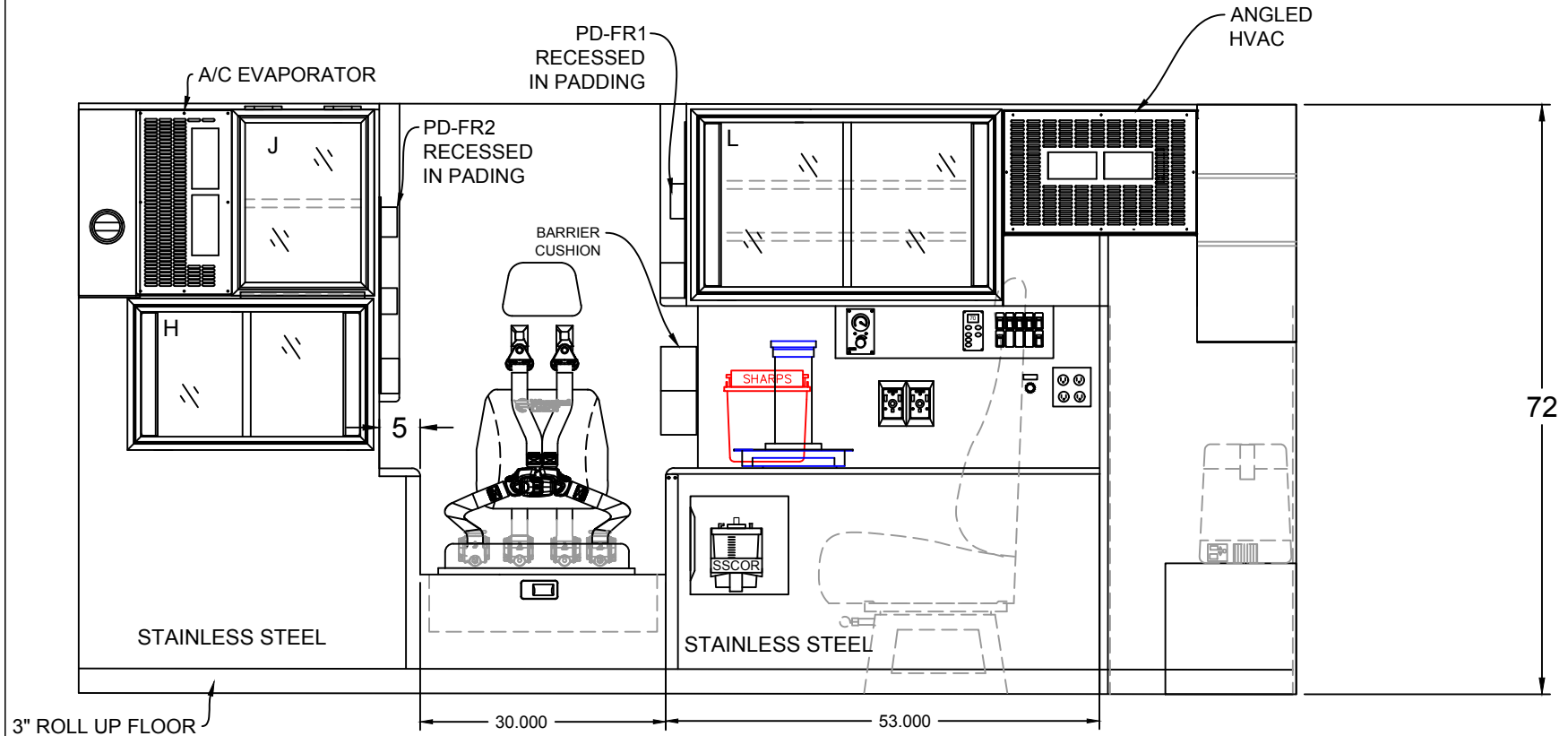

INTERIOR CABINET DIMENSIONS IN INCHES

CABINET	HEIGHT	WIDTH	DEPTH		CABINET	HEIGHT	WIDTH	DEPTH	
J	22.75	16.75	20.50						
H	18.50	30.00	IS/OS						
L	23.75	38.75	14.00						



F450 TYPE I FORD 2019

LEFT INTERIOR

DATE: 1/29/20

SCALE

DWN BY

AP

DWG NO

5 / 9

BE ADVISED THAT THESE ARE PRELIMINARY LAYOUTS INTENDED TO ILLUSTRATE DESIGN INTENT AND DIMENSIONS ARE FOR REFERENCE ONLY PRIOR TO FINAL ENGINEERING

CA165462

BRAZORIA COUNTY ESD 3

153 x 98 x 72

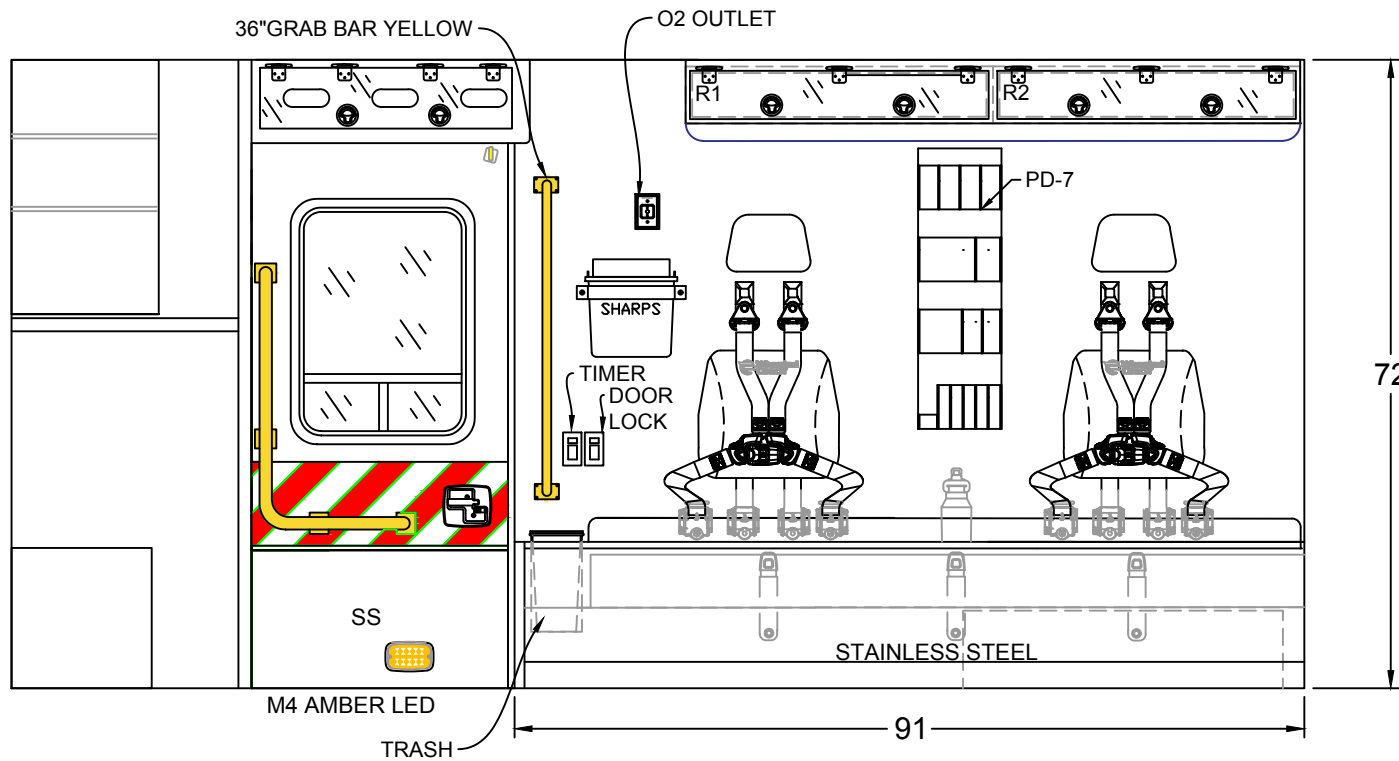

INTERIOR CABINET DIMENSIONS IN INCHES

COMPT.	HEIGHT	WIDTH	DEPTH		COMPT.	HEIGHT	WIDTH	DEPTH	
E	19.00	26.50	12.00						
R1	8.00	31.00	9.00						
R2	8.00	31.00	9.00						



F450 TYPE I FORD 2019
RIGHT INTERIOR

DATE: 1/29/20 SCALE:
DWN BY: AP DWG NO: 6 / 9

BE ADVISED THAT THESE ARE PRELIMINARY LAYOUTS INTENDED TO ILLUSTRATE DESIGN INTENT AND DIMENSIONS ARE FOR REFERENCE ONLY PRIOR TO FINAL ENGINEERING

CA165462

BRAZORIA COUNTY ESD 3

153 x 98 x 72

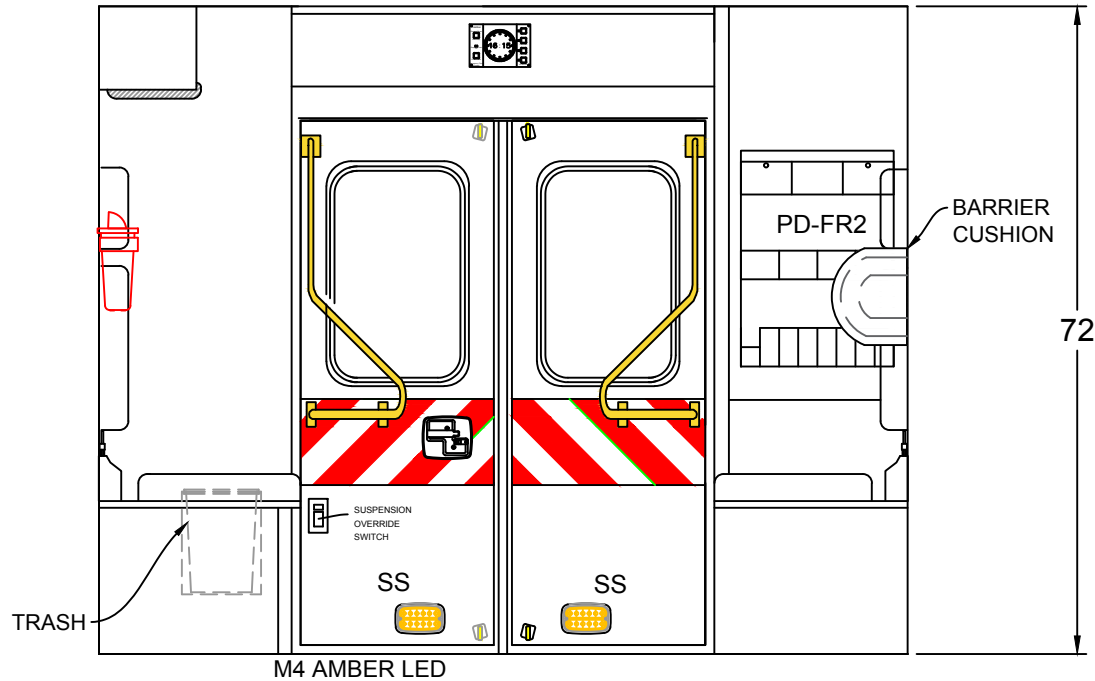

INTERIOR CABINET DIMENSIONS IN INCHES



COMPT.	HEIGHT	WIDTH	DEPTH	COMPT.	HEIGHT	WIDTH	DEPTH

F450 TYPE I FORD 2019
REAR BULKHEAD INTERIOR

DATE: 1/29/20 SCALE

DWG BY: AP DWG NO: 7 / 9

BE ADVISED THAT THESE ARE PRELIMINARY LAYOUTS INTENDED TO ILLUSTRATE DESIGN INTENT AND DIMENSIONS ARE FOR REFERENCE ONLY PRIOR TO FINAL ENGINEERING

CA165462

BRAZORIA COUNTY ESD 3

153 x 98 x 72

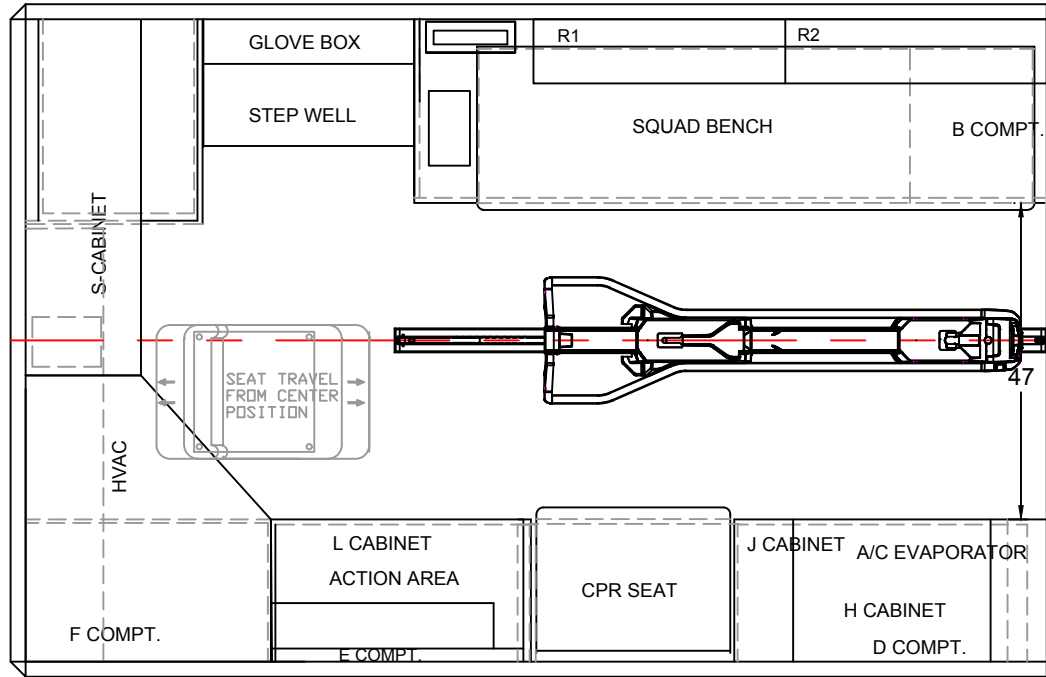

BE ADVISED THAT THESE ARE PRELIMINARY LAYOUTS INTENDED TO ILLUSTRATE DESIGN INTENT AND DIMENSIONS ARE FOR REFERENCE ONLY PRIOR TO FINAL ENGINEERING

INTERIOR CABINET DIMENSIONS IN INCHES

CABINET	HEIGHT	WIDTH	DEPTH	CABINET	HEIGHT	WIDTH	DEPTH



F450 TYPE I FORD 2019
FLOOR PLAN

DATE:	1/29/20	SCALE
DWN BY	AP	DWG NO 8 / 9

CA165462

BRAZORIA COUNTY ESD 3

153 x 98 x 72

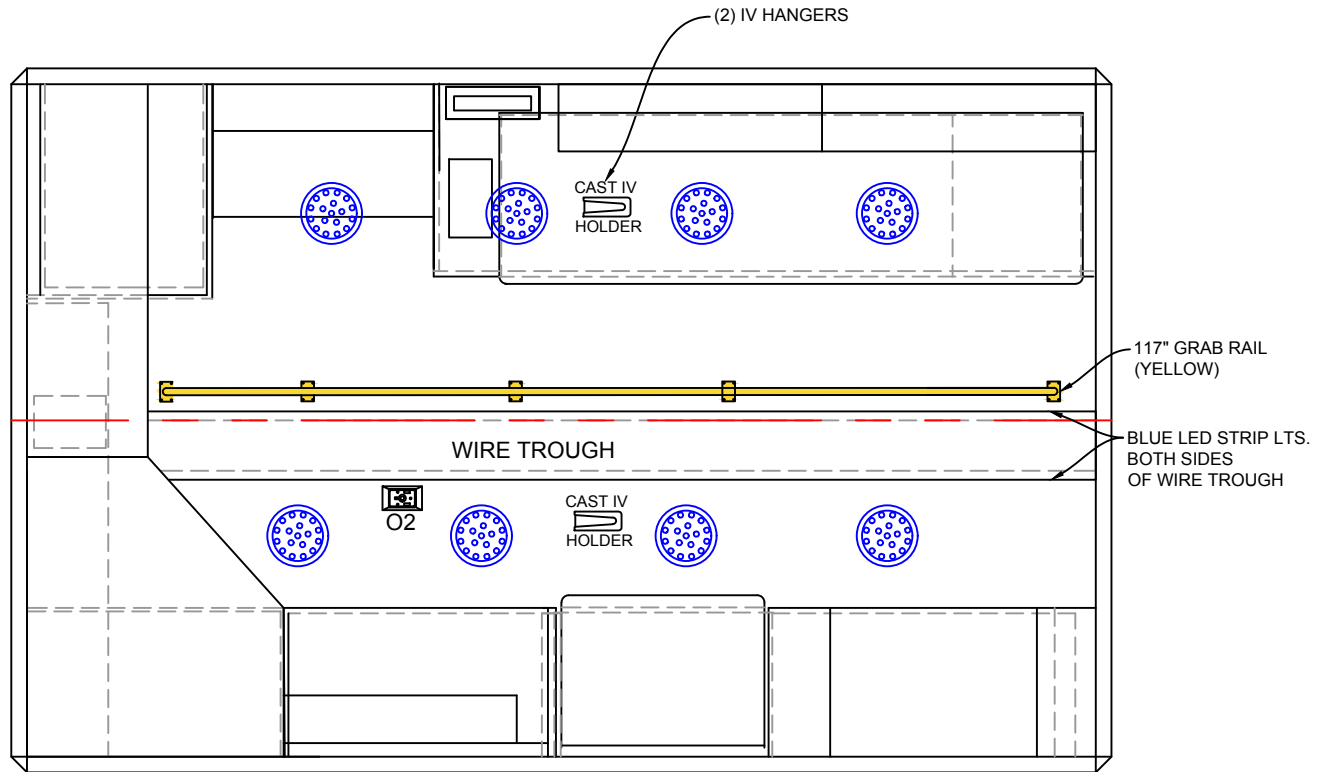

BE ADVISED THAT THESE ARE PRELIMINARY LAYOUTS INTENDED TO ILLUSTRATE DESIGN INTENT AND DIMENSIONS ARE FOR REFERENCE ONLY PRIOR TO FINAL ENGINEERING

INTERIOR CABINET DIMENSIONS IN INCHES

CABINET	HEIGHT	WIDTH	DEPTH	CABINET	HEIGHT	WIDTH	DEPTH



F450 TYPE I FORD 2019
LINER

DATE: 1/29/20 SCALE
DRAWN BY: AP DWG NO: 9 / 9